

I-9105R
Intelligent Reflective Beam Detector
Installation and Operation Manual
(Issue 2.03 , February 2006)

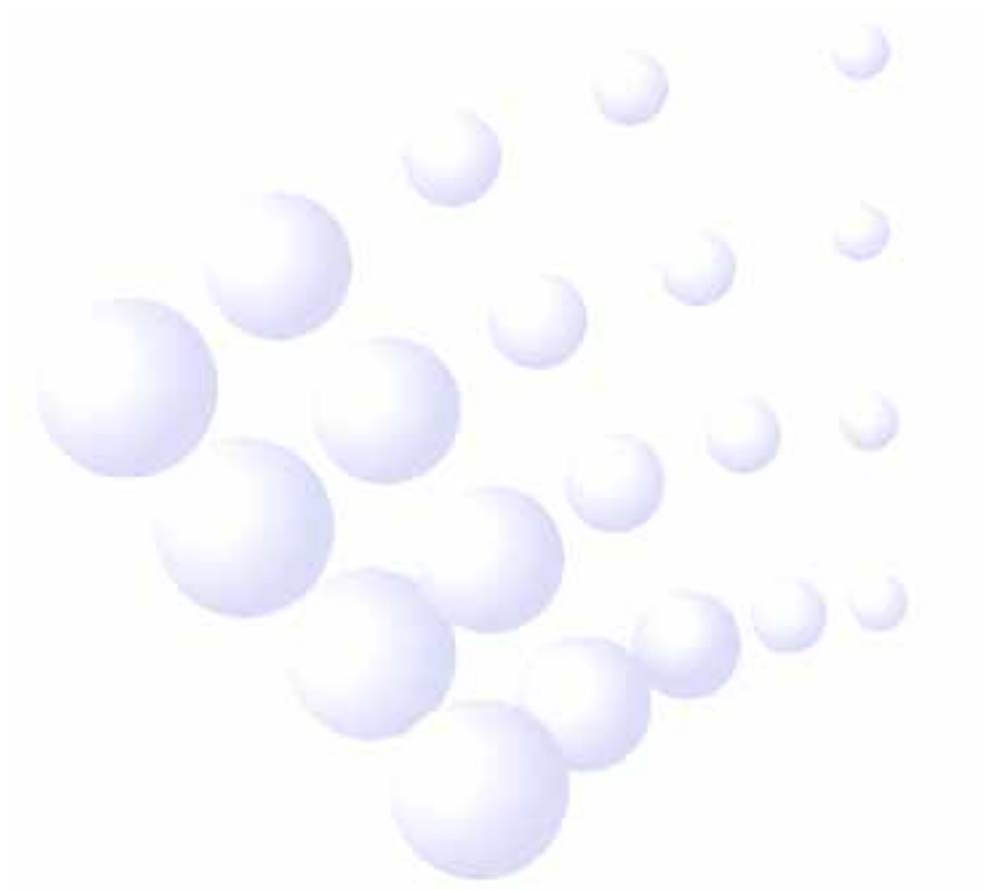

CONTENTS

I	General	1
II	Features	1
III	Technical Specifications	1
IV	Structure and Operation Principle	2
V	Mounting and Wiring	4
	1. Ambient Conditions for Installation	4
	2. Mounting Height and Position.....	5
	3. Mounting.....	7
	4. Wiring	10
VI	Commission	10
VII	Cautions	12
VIII	Operation	12
	1. Reading Information	12
	2. Setting Address Code.....	12
	3. Setting Sensitivity Level.....	12
	4. Setting the Device Type.....	13
	5. Other Functions	13
IX	Troubleshooting	13
X	Maintenance	15
XI	Accessories	15
	Appendix 1 Warnings	16
	Appendix 2 Warranty	17

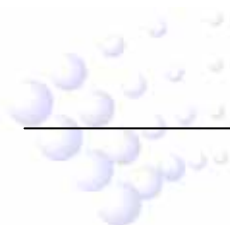

I General

I-9105R Intelligent Reflective Beam Detector (hereinafter called the detector) is an addressable reflective infrared beam smoke detector that can be connected with fire alarm control panel directly, transmitting state information through loop between the detector and control panel. The detector must be used together with a reflector. The number of reflector(s) to be used (one or four) depends on the distance from the detector.

With excellent built-in microprocessor, the detector has strong ability of analysis and judgment. The detector can carry out system adjustment, compensation of variation of ambient data, and judgment of fire and fault through fixed algorithm. Integrating LONworks technology, the detector features high upload speed and abundant information. With new and reasonable design, esthetical pleasing, flexible judgment and alignment method it's easy to install and adjust. The sensitivity of the detector can be set through hand held programmer in field, decreasing the demand for cleanliness of field conditions, and enlarging application areas. The detector is applicable to historical buildings, warehouses, large storages, shopping malls, leisure centers, exhibition halls, hotel lobbies, printing houses, clothing factories, museums and prisons, as well as places where slight smoke particles.

II Features

1. Wide operating voltage range, big monitoring areas.
2. Combination of the emitting and receiving part makes mounting easy and optical pathway accurate.
3. Built-in microprocessor enables intelligent judgment of fire alarm and fault.
4. The detector can calibrate automatically, which ensures a single person complete adjustment in short time. It's also convenient to operate.
5. Self-diagnosis function can monitor the inner fault.
6. Automatic compensation for factors weakening received signals, such as dust contamination, positional excursion and ageing transmitter.
7. Simple to control and operate by integrating LONworks protocol.
8. The address can be programmed in field.
9. Two sensitivity levels can be set in field.
10. The detector's optical pathway is designed with strong anti-interference ability.
11. SMT processing technology.
12. Attractive and decent appearance.

III Technical Specifications

1. Operating Voltage: Power voltage 15VDC ~ 28VDC
Loop voltage 15V ~ 28V
2. Operating Current:

Power current: Commission current 20mA

Standby current 8mA

Alarm current 12mA

Loop current 2mA

3. Angle of Adjusting: $-6^{\circ} \sim +6^{\circ}$
4. Dependency Angle of Optical Pathway Orientation: $\pm 0.5^{\circ}$
5. Sensitivity Level: Level 1: High sensitivity.
Level 2: Low sensitivity.
6. Indication of Detector State:
Commission: Green LED and yellow LED are lit or flash in a certain way. See details in Section VI Commission.
Normal monitoring state: Red LED flashes periodically.
Fire: Red LED constantly illuminates, and yellow LED turns off. The fire signal has to be cleared by the control panel, which turns on the detector's red LED in fire alarm condition.
Fault: Yellow LED constantly illuminates. The detector clears the fault signal automatically if the condition causing the fault disappears.
Optical pathway obscured totally: the detector first gives fault signal and turns on yellow LED. 20 second later, it alarms fire again, and the control panel illuminates its red LED and turns off yellow LED. **Note: In this case, it does not necessarily mean there is a fire. After the obscuration is removed, the detector clears the fault signal automatically. Fire signal has to be cleared by the control panel.**
7. Operating Environment:
Temperature: $-10^{\circ}\text{C} \sim +50^{\circ}\text{C}$
Relative Humidity 95%, non condensing
8. Monitoring Area: Maximum monitoring area: $14 \times 100 = 1400\text{m}^2$
Maximum width: 14m
9. Length of Optical Pathway: 8m ~ 100m
10. Ingress Protection Rating:
Under common environment, ingress protection rating is IP20.
Under special environment, ingress protection rating is IP66 through glue-seal treatment.
11. Dimension: length: 206mm width: 95mm thickness: 95mm
12. Material and Color of Enclosure: ABS, gray
13. Weight: 450g
14. Mounting Hole Spacing: Spacing for embedding: 158mm
Spacings for surface mounting: 79mm \times 96mm

IV Structure and Operation Principle

1. Appearance of the detector is shown in Fig. 1.

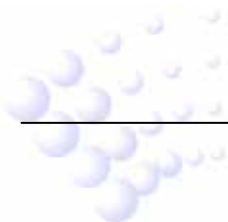



Fig. 1 Appearance

2. Internal devices of the detector and positions to be glued are shown in Fig. 2.

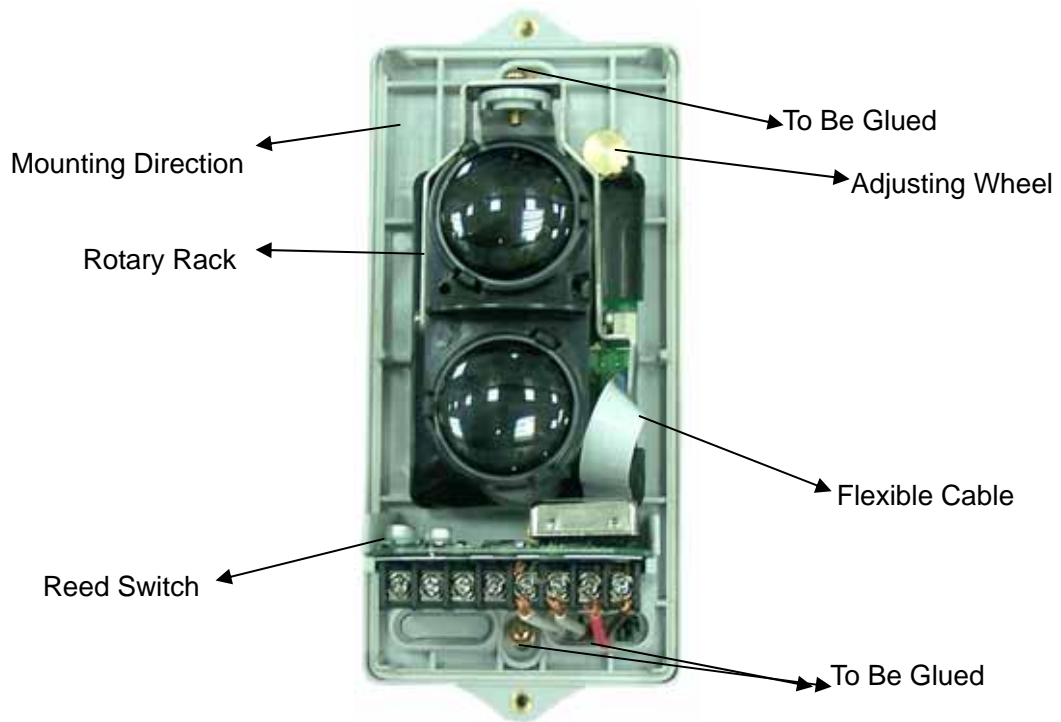

Fig. 2 Internal Devices and Positions to Be Glued

3. Operation Principle

The detector and reflector are placed oppositely. The detector includes emitting part

and receiving part. Infrared beam of certain intensity sent out from the emitting part is reflected by the right-angle prisms of the reflector, and then received by the receiving part of the detector. The receiving part simultaneously collects and amplifies the returned infrared beam, analyze and judge the collected signals through its microprocessor. When the detector is in normal monitoring state, the intensity of infrared beam received by the receiving part is steady at a certain level. When smoke particles enter the detecting area, the intensity of infrared light received by the receiving part falls owing to light scattering. When the smoke particles reach a certain density, and the intensity of infrared light received by the receiving part is reduced below the preset threshold value, the detector alarms fire, illuminates red LED, and passes the fire signal to the control panel. Operation principle is shown in Fig. 3.

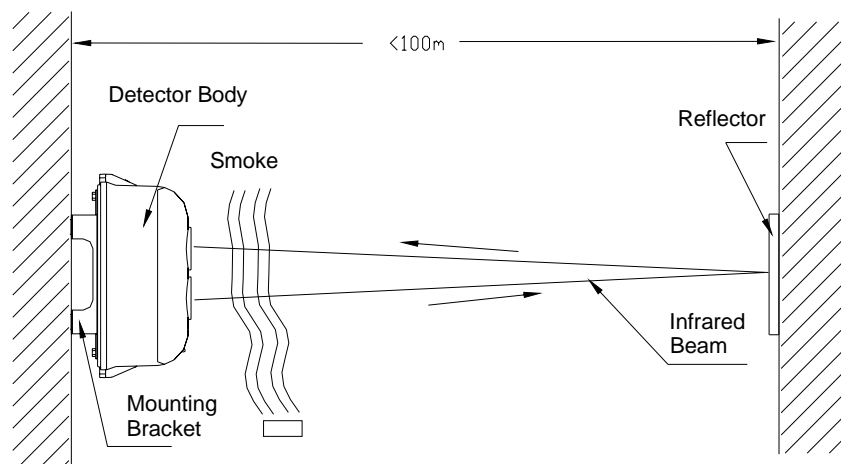

Fig. 3 Operation Principle

V Mounting and Wiring

1. Ambient Conditions for Installation

The detector works on light obscuration principle. Avoid any fixed or moving obscuration in its optical pathway when installing.

The wall for mounting either the detector or the reflector should be firm and smooth. The detector is mounted vertical to the wall. The wall may seem to be smooth, but corrugated or uneven, or may be changed by the environment (in rainy season or in winter) and the installer should ensure the detector not affected by these factors. If the detector is installed on sustaining rack similar to metal tube, make sure the sustaining rack fixed firmly.

Not Fit For Locations where:

- Space height is over 40m.
- It is not roofed.
- Space height is less than 1.5m.
- There are a lot of dust, powder or vapor.
- It is clean normally, but can be dusty in some special cases.

- Temperature is high. **Note: Temperature at top part of a workshop with transparent roof may be over 50 when there is sunshine.**
- There is no access for maintenance.
- The Mounting wall or fitting is greatly affected by mechanical vibration.
- There are fixed or moving objects within 1m from the detector's optical pathway.
- There is strong magnetic field.

2. Mounting Height and Position

The mounting height of the detector and reflector should be most accessible by smoke into beam zone. The following recommendations are for reference:

- 1) When space height is not over 5m, the detector and reflector should be mounted on the two facing walls 0.5m from the ceiling, see Fig. 4.

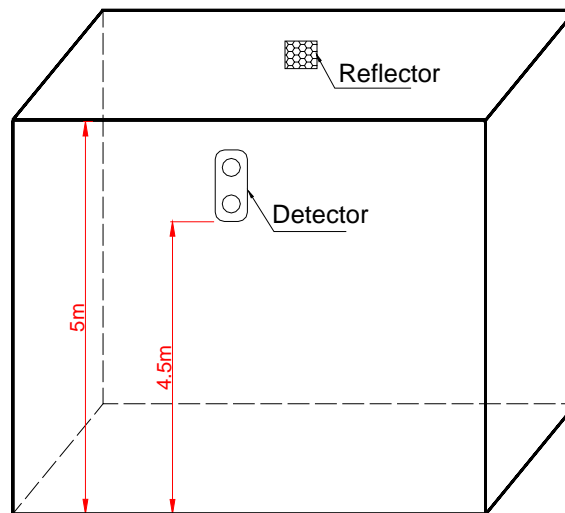
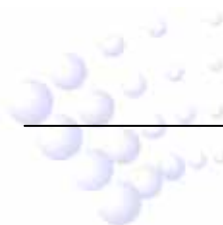

Fig. 4 Mounting

- 2) When space height is between 5m and 8m, the detector and reflector should be mounted on the two facing walls 0.5m to 1m from the ceiling, see Fig. 5.



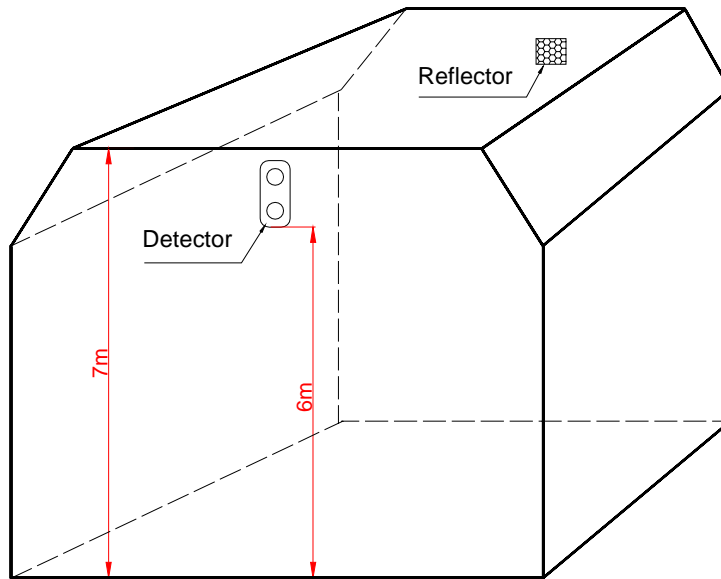

Fig. 5 Mounting

- 3) When space height is more than 8m, the roof is normally gabled without ceiling, the detector and reflector should be mounted on the two facing walls about 8m from the floor, ensuring that the vertical distance between the detector/reflector and top of the building is more than 0.5m, see Fig. 6. The distance should be 7m from the detector to the floor.

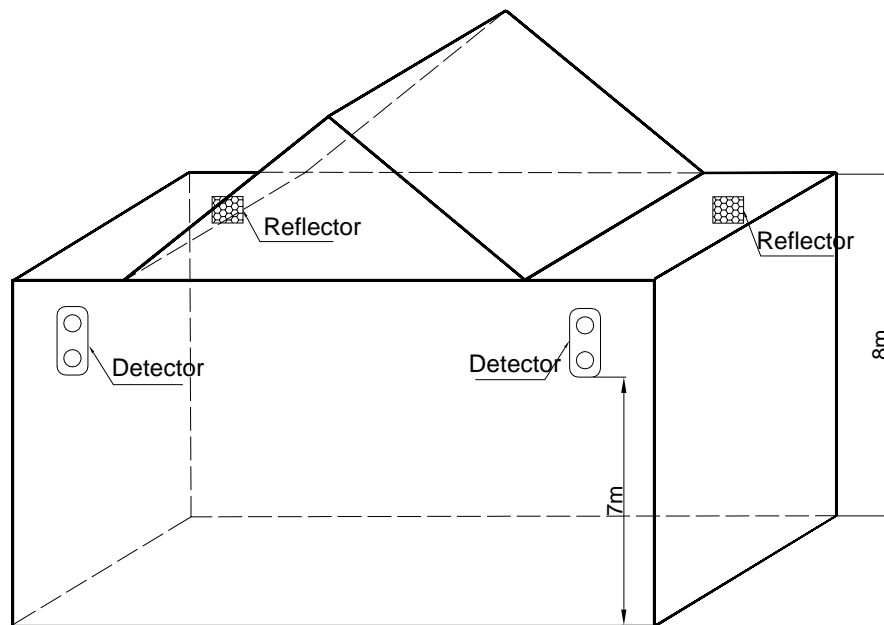
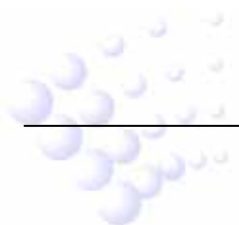

Fig. 6 Mounting

- 4) For gable structure with space height about 8m, the detector and reflector should be mounted on the two facing walls 1.5m from the gabled girder, see Fig. 7.



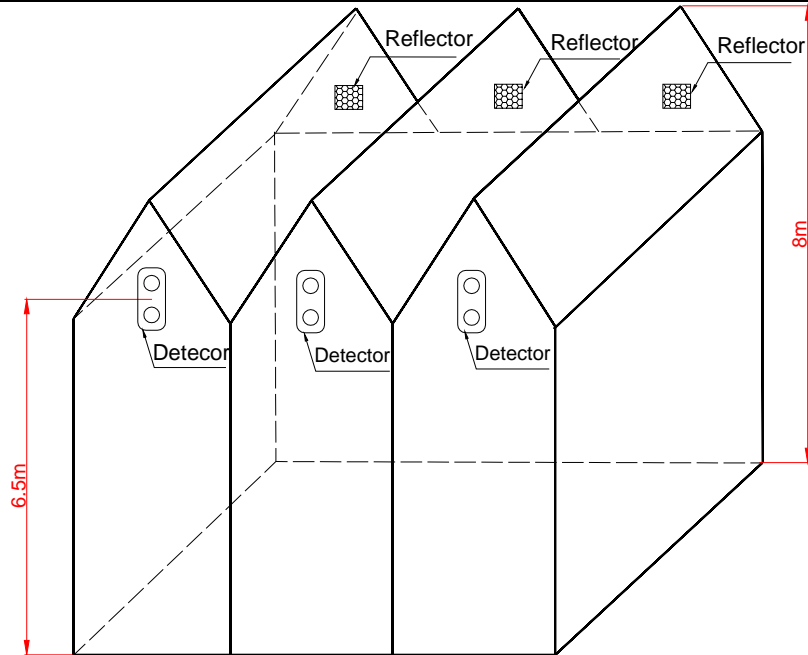

Fig. 7 Mounting

5) If the surroundings are glass or transparent plastic, please place the detector on the south wall in a building. If the detector cannot be mounted northward, then place the detector on the west wall. For applications where sunlight can reach the detector after reflected, please consider mounting a sunshade over the detector's optical pathway or contact our field application engineer for a solution.

3. Mounting

1) Setting Length of Optical Pathway

Before installation, you need to set the length of optical pathway first by setting device type of the detector. The detector can work at two levels of length. When mounting distance between the detector and the reflector is not less than 40m (but not more than 100m), the detector type should be set at "52" (factory default). When the mounting distance between the detector and the reflector is less than 40m (but more than 8m), the detector type should be set at "51". See Section VIII Operation for detailed setting methods.

2) Mounting the Detector

Align the detector and the reflector horizontally on the two facing walls in monitoring area. See Fig. 8.

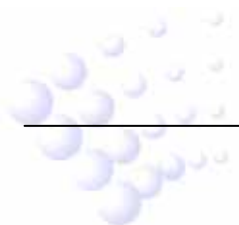

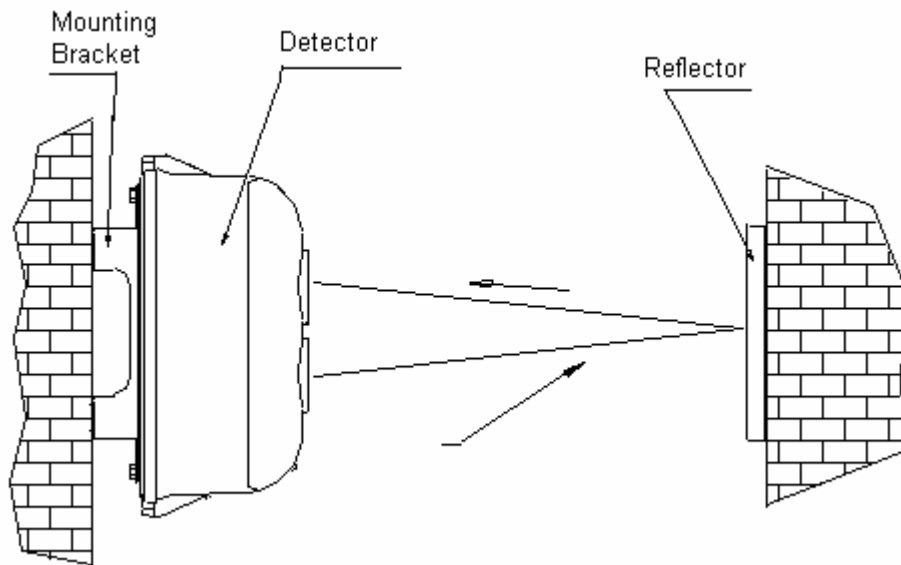

Fig. 8 Mounting

The detector can be surface-mounted in two ways: with wiring tube embedded or wiring tube surface-mounted.

(1) Embedding wiring tube

- a. Remove the detector's top cover.
- b. Align the base of the detector over the embedded box and mark the positions of mounting holes on the wall.
- c. Drill two holes at the marked positions, and push two $\varnothing 6$ plastic expansion bolts in.
- d. Thread the wires through wire-in hole, ensuring the length of wires inside convenient for connection.
- e. Fix the detector base on the wall with two plastic expansion bolts and flat washers

Mounting method is shown in Fig. 9.

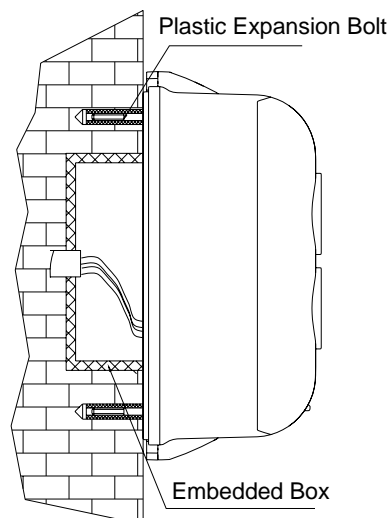

Fig. 9 Wiring Tube Embedded

(2) Wiring tube surface mounting

- a. Put the mounting bracket at position intended to install the detector; mark the locations of the four holes of mounting bracket on the wall.
- b. Drill the holes on marked positions, and push $\varnothing 6$ plastic expansion bolts in.
- c. Fix the mounting bracket on the wall with four $\varnothing 6$ plastic expansion bolts and flat washers.
- d. Remove the detector's top cover; thread the wires through the wire-in hole, ensuring the length of wires inside convenient for connection.
- e. Fix the detector base onto the bracket with two M4 x 10 bolts and flat washers.

Note: If there is strong magnetic or electric field, please connect the metal mounting bracket of the detector with ground reliably to ensure stable operation.

Mounting method is shown in Fig. 10.

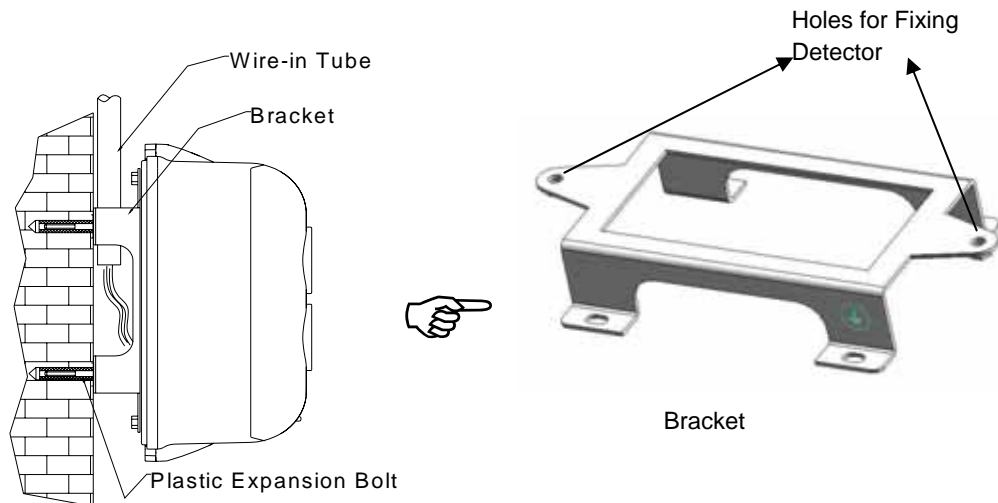
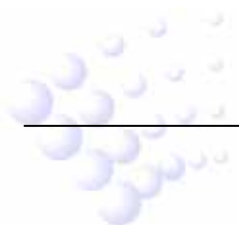

Fig. 10 Wiring Tube Surface Mounted

3) Mounting the Reflector

The reflector is mounted opposite the detector but in line with it. When the distance between the detector and the reflector is more than 8m (less than or equal to 40m), one reflector is enough. When the distance is more than 40m (less or equal to 100m), four reflectors are needed. Two $\varnothing 6$ plastic expansion bolts are needed to fix a single reflector. Mounting size is shown in Fig.11a. If four reflectors are needed, place them seamlessly as shown in Fig. 11b.



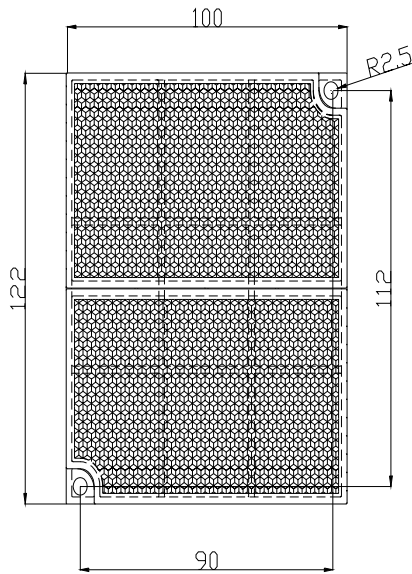

Fig. 11a Single Reflector

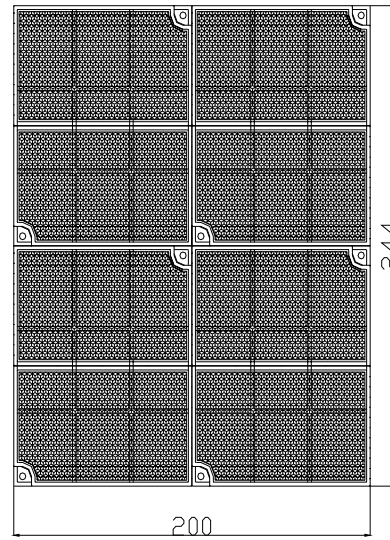

Fig. 11b Four Reflectors (not to scale)

4. Wiring

Connect 24VDC power wire (without polarity) to terminal D1 and D2 of the detector in field. Connect the control panel loop (without polarity) to terminal Z1 and Z2. The reflectors need not to connect with wires. Terminals are shown in Fig. 12.

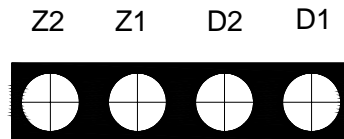

Fig. 12 Terminals

Wiring: BV cable with cross section not less than 1.5mm^2 for power cable connecting with D1 and D2. Twisted pair with cross section not less than 1.0mm^2 for signal wires connecting with Z1 and Z2.

Note: If the detector is mounted in special environment where there are slight dust or where it's damp, seal the three positions shown in Fig. 2 (two mounting holes and one wire-in hole) with glass glue or 703 silica gel after the detector is fixed and wiring is finished to ensure the detector work stably.

VI Commission

1. Steps:

- 1) Take off the protective membrane carefully on the surface of the reflector and. Do not scratch or contaminate their surfaces.
- 2) Remove the detector's top cover, and connect to 24VDC power and the control panel power. Two minutes later, put the magnet of commission tool close to the reed switch (around the red LED) of detector's interface board. There may be two

cases with the LEDs:

- (1) Green LED flashes.
- (2) Green LED illuminates continuously.

Take away the commission tool.

3) If green LED flashes, it means the received light is quite weak (the slower the flashing frequency, the weaker the received light signal is). Tune the adjusting wheel and rotary rack on the detector to align the light beam until green LED is lit continuously, showing that the light received by the detector is strong. Then stop regulating and enter step 4). If green LED illuminates continuously, it means the received light is quite strong, you can go straight to step 4).

Note: Observe the detector's optical pathway carefully to ensure that the received light signal is reflected by the reflector rather than by obscurations like wall, ceiling, or pillar. If uncertain, verify by covering the reflector with opaque objects.

4) Put on the top cover gently, and screw the two bolts on the cover.

5) The green LED illuminates continuously. Put the magnet of commission tool close to the zone where marked (M) until yellow LED illuminates constantly, then remove the filter quickly and make sure there is no obscuration on the optical pathway. About 5 seconds later, the detector begins to adjust automatically. Yellow LED flashing means weak light, green LED flashing means strong light. If red LED, yellow LED and green LED flash alternately, this means the detector failed to adjust automatically and cannot enter normal monitoring state. Please open the detector's top cover and do adjustment from step 2). If yellow LED and green LED illuminate no more, and red LED flashes periodically, this means the detector is at the best position and has entered normal monitoring state. The commission is finished.

2. Registration

Register the detector, please see the details in the relevant control panel's installation and operation manual.

3. Fire alarm test

After the detector has been in normal monitoring state for 20 seconds, cover the receiving window and emitting window with the IR Light Filter (please use the part for fire alarm test), the fire alarm control panel should alarm fire in 30 seconds and red LED should turn on. Remove the filter and clear the fire alarm from the control panel, red LED should turn off and the detector should be in normal polling.

4. Fault test

Cover the receiving or emitting window of the detector quickly with the IR Light Filter (please use the part for commission) to obscure the optical pathway. Yellow LED of the detector should be turned on. Taking off the filter immediately, yellow LED of the detector should be turned off.

5. Failed Detector

During testing, repair failing detectors according to directions in Section IX *Troubleshooting* and X *Maintenance*, and test again, if they fail again, return them to factory for repair.

VII Cautions

1. Power up only after all devices are well connected.
2. Adjust the detector after installation and maintenance.
3. During adjustment, the detector may give fault signal (fault passive output contact is closed), but this will not affect the commission.
4. The detector base should be fixed directly on solid wall or frame that will not be deformed by vibration. Any deformable material such as paperboard, plastic board, foam board or thin wood board should not be placed between the base and the wall or the bracket.

VIII Operation

The detector can be simply programmed by a programmer. Address, device type and sensitivity level of the detector can be set with P-9910B Hand Held Programmer. Open the detector's top cover, connect I²C cable of hand held programmer (PS/2 cable) with XT3 of the detector. Turn on the power of hand held programmer, input 2, 5, 9 and *Function* to enter I²C programming mode, the screen shows a "0". After carrying out operation needed, input 2, 5, 9 and *Function* again to exit I²C programming mode and return to power-on state.

1. Reading Information

The hand held programmer can conveniently get original information like address code, sensitivity level and device type. See details below:

- Enter I²C programming mode, the screen shows a "0".
- Press *Test*, the screen shows the address code of the detector.
- Press *Up*, the screen shows sensitivity level and device type in sequence.
- Press *Down*, the screen shows above contents in opposite way.

2. Setting Address Code

The detector offers address code programming for field application. See operation below:

- Enter I²C programming code, and the screen is a "0".
- Input address code for programming (1 ~ 242) .
- Press *Program* to start programming. "P" will be shown when successful, otherwise an "E" will be shown.
- If programming is successful, press *Clear*, the screen will show a "0", and you can go on with further operations.
- If programming fails, press *Clear*, the screen will show a "0", input address code once more.

3. Setting Sensitivity Level

The hand held programmer can set two sensitivity levels to the detector. 2 is sensitivity one. 3 is sensitivity two. See the details below:

- Enter I²C programming mode of hand held programmer, the screen shows a “0”.
- Input unlock password and press *Clear*, the lock is opened.
- Press *Function* then the figure “3”, the screen shows a “ - ”.

- Input sensitivity level to be set, and press *Program* to begin programming. The screen will show a “P” when if programming is successful, otherwise it will show an “E”.
- Press *Clear*, the screen shows a “0”, and you can go on with further operations.

4. Setting the Device Type

You can also set the device type of the detector by hand held programmer. See detailed operations below:

- Enter I²C mode of the programmer, the screen shows a “0”.
- Input unlock password and press *Clear*, the lock is opened.
- Press *Function* and then figure “4”, the screen shows a “ - ”.
- Input the device type, press *Program*, to begin programming, “P” will be shown when successful, otherwise an “E” will be shown.
- Press *Clear*, the screen shows a “0”, and you can go on with further operations.

Note: The hand held programmer has lock password to prevent non-special personnel from modifying some important data. Unlocking password is “456” , locking password is “789”.

5. Other Functions

1) Automatic Compensation of Light

When dust exists in the working environment of the detector, the emitting window, receiving window and reflector will be covered with dust, which will affect normal operation. In order to solve the problem, we designed the function of automatic compensation of light. When there is dust on windows, the detector can judge the amount of dust, and compensate the received signal through internal program and circuit to ensure the detector can continue to work normally. The detector gives fault signal when dust on the lens and reflector surface reaches a certain level and light compensation reaches the limit for the detector to work normally.

2) Self-diagnosis on Optical Signal

The detector has functions of checking emitting, receiving and amplifying circuit. When there is fault with these three parts of circuit during operation, the detector will generate fault information.

IX Troubleshooting

Common problems and repair methods are as follows:

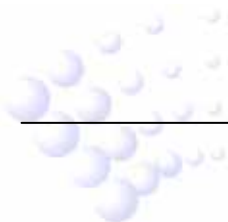
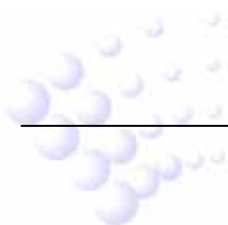

Table 1

Problems	Reasons	Repair Methods
Working indicators not lit after power on.	<ul style="list-style-type: none"> a) 24V power off b) Working indicators damaged. c) Transient suppressor VD12 damaged. d) Diode VD1, VD2, VD10, VD11 breakdown resulting in short circuit with ground. e) N1, N2 damaged. f) The flexible cable inside was not connected, or not connected correctly. 	<p>If the problems are mentioned in a) ~ e) , replace the component with problem. If in f) connect again in right way.</p>
Fault indicator constantly illuminates after power on	Wrong device type.	Program the device type 51 or 52 again according to Section VIII <i>Operation</i> .
Alarms loop fault after power register	<ul style="list-style-type: none"> a) Diode VZ1, VZ2, VD3, VD4 breakdown resulting in short circuit with ground. b) Momentary restraint VD13 damaged. 	Replace the component with problem.
Gives fault signal after power register	<ul style="list-style-type: none"> a) The detector is not in normal working state. b) The detector top cover is not on. 	Commission once more.
Not register after power	<ul style="list-style-type: none"> a) The detector connects with loop loosely. b) 24V power does not offer electricity. c) N3, N4 damaged. d) The soft cable inside the detector does not insert or incorrectly insert. e) N1 and N2 damaged 	Replace the component with problem and commission again.
Green LED constantly flashes after power on	<ul style="list-style-type: none"> a) Emitting diode or circuit damaged. b) Receiving diode or amplifying circuit damaged. 	Replace the component with problem.
Gives fault signal after a period of normal operation	The detector can't work normally.	Commission once more
Alarms fire after operation for some time, and gives fault signal after restart	The detector has deviated due to external vibration.	Commission once more



Fire signal cannot be cleared	a) There are obscuration on the optical pathway between the detector and the reflector. b) The angle of optical pathway has changed and need to be aligned again. c) The emitting diode or circuit damaged. d) The photodiode or amplifying circuit damaged.	If the problems are mentioned in a), b), commission once again. If in c), d), e) replace the component with problem.
The control panel can't receive fire and fault signals.	Wrong connection with inadaptable wire.	Connect correctly.

X Maintenance

1. If the detector gives fault signal after working for a long time, first check whether the detector is damaged or not, and make sure that it is fixed to the wall or other fittings. Then check whether it is the accumulating dust and positional excursion, causing compensation fault, then consider other types of fault.
2. If emitting window, receiving window and reflector surface are found contaminated, clean them with soft cloth and alcohol (avoid scraping) . Never use water or other chemicals. Commission the detector again after cleaning.
3. The detector is fire protection product, whose operation must be well recorded by the personnel on duty and shift.
4. Personnel on duty should be familiar with the functions and operation process of the device to avoid mis-operation.
5. Test alarm function once half a year.

XI Accessories

Accessories provided with the detector are as follows:

- Four Ø6 plastic expansion bolts.
- One bracket.
- One IR Light Filter.
- Two M4 × 10 cross recessed pan head screws.
- Six Ø4 flat washers.
- One commission tool.

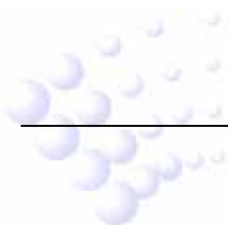

Appendix 1 Warnings

Limitations of Smoke Detector

The smoke detector is designed for triggering and initiating emergency fire equipments, but it only functions when matching with other equipments. Installation of this smoke detector must conform to electrical codes and standards in your country.

The smoke detector cannot work without power. It cannot work if power is cut off for any reason.

The smoke detector may not sense fire that where smoke cannot reach it, such as in chimneys, in walls, on roofs, or on the other side of closed doors.

The detector also may not sense a fire on another level of a building. Therefore, detectors should be placed on every level of a building.

All types of smoke detector have limitations. Because fires develop in different ways and are often unpredictable in their growth, it is impossible to predict which type of detector will provide the earliest warning. No types of smoke detector can sense every kind of fire every time. Generally speaking, detectors may not warn you about fires caused by insufficient safety measures, violent explosions, leaking gas, improper storage of flammable materials like diluents and other safety hazards, arson or children playing with fire. The alarm of a smoke detector used in high velocity environment will be delayed due to dilution of smoke by frequent and fast airflow. What's more, the smoke detector has to be maintained frequently because there will be more dust contamination.

The smoke detector cannot last forever. In order to keep the detector working in good condition, please maintain the equipment continuously according to recommendations from manufacturers and relative nation codes and laws. Take specific maintenance measures on the basis of different environments. The smoke detector contains electronic parts. Even though it's made to last for a long period of time, any of these parts could fail at any time. Therefore, test your smoke detector at least every half-year according to national codes or laws. Any smoke detectors, fire alarm devices or any other components of the system must be repaired or replaced as long as they fail.

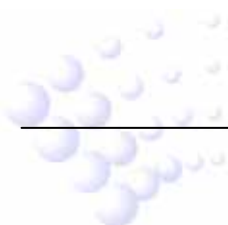

Appendix 2 Warranty

Our company warrants that the detector will be free from defects in design, materials and workmanship. The warranty is valid for a period of 2 years from time of dispatch. This warranty shall not apply to any product that is found to have been damaged, improperly installed or used in any way not in accordance with the instructions supplied with the product. Anybody, including the agents, distributors or employees, is not in the position to amend the contents of this warranty. Products not covered by this warranty shall also be returned for repair. Please return the products together with a description of fault and possible reason to the company.

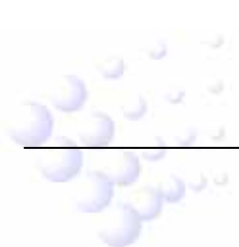



GST China

Gulf Security Technology Co., Ltd.
No. 80, Changjiang East Road, QETDZ, Qinhuangdao, Hebei,
P. R. China 066004
Tel: +86 (0) 335 8502528
Fax: +86 (0) 335 8508942
Email: sales@gst.com.cn
www.gst.com.cn

GST UK

Global System Technology PLC
Enterprise Glade, Bath Lane, Moira, South Derbyshire,
England. DE12 6BD
Tel: + 44 (0) 1283 225 478
Fax: + 44 (0) 1283 220 690

Rigional Office

PO Box 17998 Unit ZA04 JEBEL ALI Free Zone,
Dubai, UAE
Tel: +971 (0) 4 8833050
Fax: +971 (0) 4 8833053
Email: tech.support@gst.uk.com
www.gst.uk.com